



Measuring converter **AD4USB**

4 inputs for standardized signal measuring
0 - 10 V, 0 - 20 mA, 4 - 20 mA

Communication and power via USB



AD4USB

Datasheet

Created: 6/5/2007

Last update: 6/15/2009 10:16 AM

Number of pages: 20

© 2009 Papouch s.r.o.

Papouch s.r.o.

Address:

**Strasnicka 3164
102 00 Prague 10
Czech Republic**

Tel:

**+420 267 314 267
+420 267 314 268
+420 602 379 954**

Fax:

+420 267 314 269

Internet:

www.papouch.com

E-mail:

info@papouch.com



CONTENT

Basic information	4
Description.....	4
Application	4
Features	4
Block diagram and operation	5
Examples of connection structure	6
Voltage measurement.....	6
Sensors with output of 0 to 20 mA and own power supply	6
Sensors with output of 0 to 20 mA, supplied through current loop.....	6
Connections.....	7
Measuring terminals.....	7
USB	7
Installation.....	8
Installation of drivers in OS Windows	8
Serial port number change.....	14
Technical parameters	17
Available Designs	18
Indications.....	18
Detailed description of communication protocol	18

BASIC INFORMATION

Description

AD4USB measuring converter is a 4-input A/D converter which enables the user to measure up to four current signals ranging from 0(4) to 20 mA or voltage between 0 and 10 V. The measured values are then transferred to a superior system in digital form. The AD4USB version communicates via USB. Powered is also via USB.



Application

- Measurement of values from sensors with voltage or current output.
- Reading sensors with standardised current signal output
- Digitalisation of measured values from level, pressure, temperature, distance and other sensors

Features

- Four analogue inputs for current or voltage
- Measuring scale divided into 10 000 divisions
- Full isolation of the measuring part from power supply and communication lines
- Measurements carried out by a multiplex 16 bit sigma-delta A/D converter
- The maximum measuring speed of each input is 406 ms
- Two measuring modes:
 - Single measurement – sends one measured value from each input upon a request.
 - Continuous measuring – measures all inputs in the set interval and regularly sends the measured values via the communication line.
- Communication via USB
- Measuring software Wix for temperatures displaying and storing for Windows
- Power supply voltage is 5 V from USB

BLOCK DIAGRAM AND OPERATION

The measuring part is fully isolated from the USB.

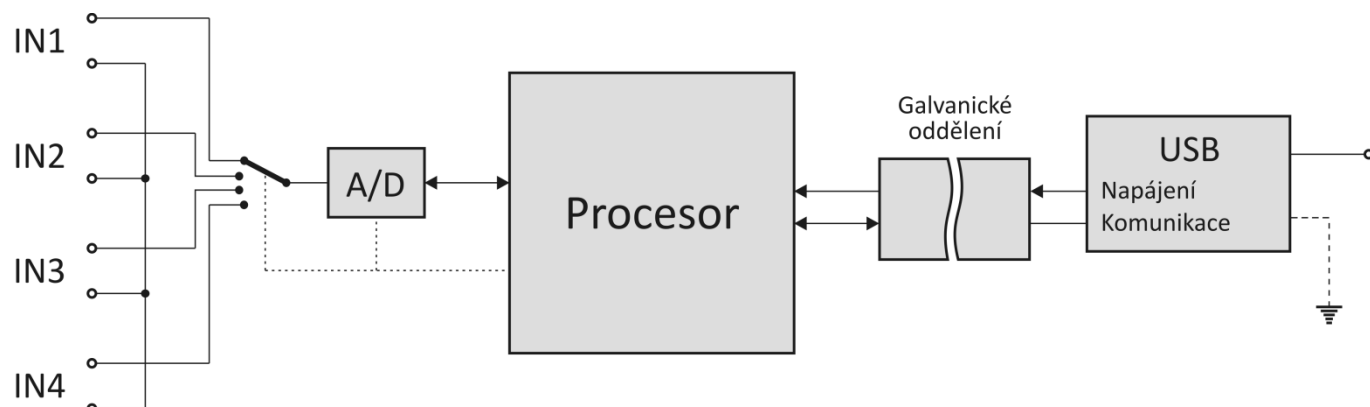

Fig. 1 – Block diagram of AD4USB

The AD4USB measuring device uses one switched sigma-delta A/D converter. After switching on the power supply voltage, the processor initiates the A/D converter and sets the device parameters according to the data saved in memory. Then the device starts to regularly measure the values of voltage found on the analog inputs and saves the results into the integrated memory.

In the continuous measuring mode AD4USB sends the measured values in configured interval.

EXAMPLES OF CONNECTION STRUCTURE

The following figures show examples of AD4USB connection structure.

Voltage measurement

An example of voltage supply connection to AD4USB terminals. The inputs are fully isolated from the USB.

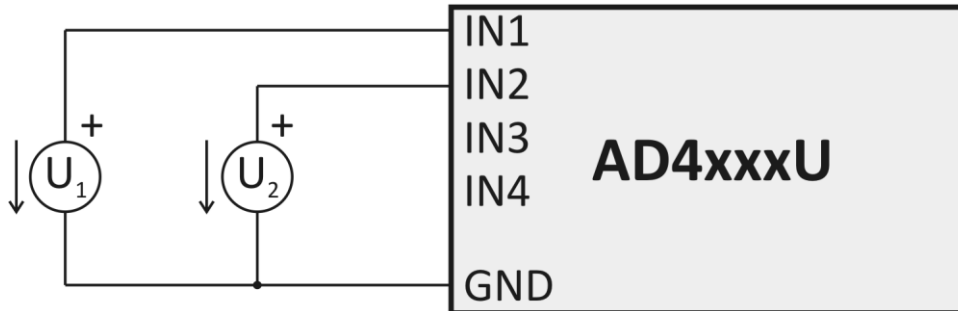

Fig. 2 – Voltage measurement

Sensors with output of 0 to 20 mA and own power supply

Sensors with currents outputs can be connected directly to the inputs with current range and supplied either from their own power supply. The inputs are fully isolated from the USB.

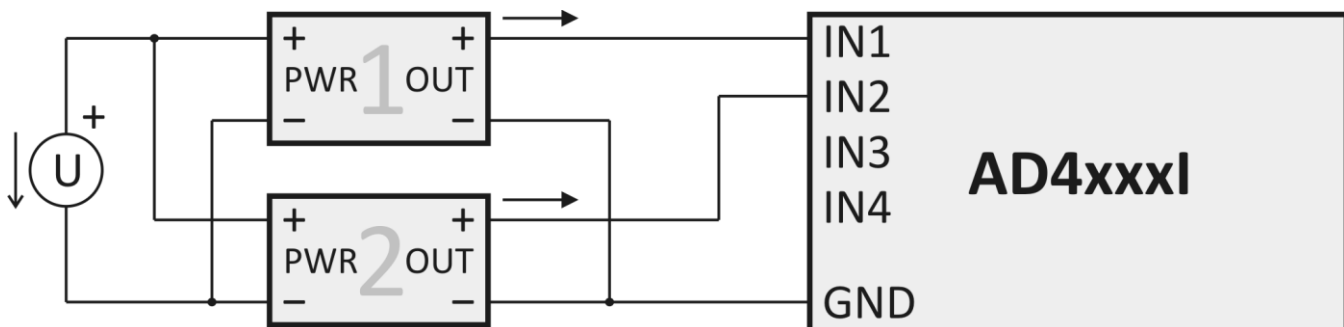

Fig. 3 – Current sensors with their own power supply

Sensors with output of 0 to 20 mA, supplied through current loop

The inputs are fully isolated from the USB.

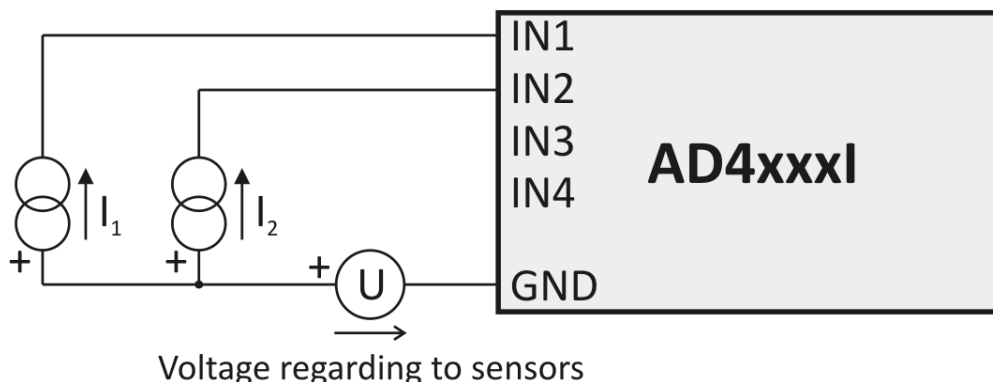

Fig. 4 – Current sensors with separate supply through current loop

CONNECTIONS

First connection

When connecting the device for the first time, connect the measuring terminals first and then the USB bus. After connecting the USB connector to a PC, install the driver software for AD4USB as described on the next page.

Measuring terminals

Note: The input types (voltage or current) are unchangeable and must be specified by the user when ordering the device. Subsequently they can be changed only by the manufacturer.

The measuring terminal unit is a six-slot terminal unit shown in Figure 6. It contains four inputs and two grounding terminals.

All four measuring terminals have a joint grounding on the two sides of the terminal unit. This grounding is isolated from other grounding terminals found in the device.

The measuring terminals have been designed for the measurement of voltage of current.

Wires can be connected individually and fixed by means of a screw (use flat bladed screwdriver 2.5 mm).

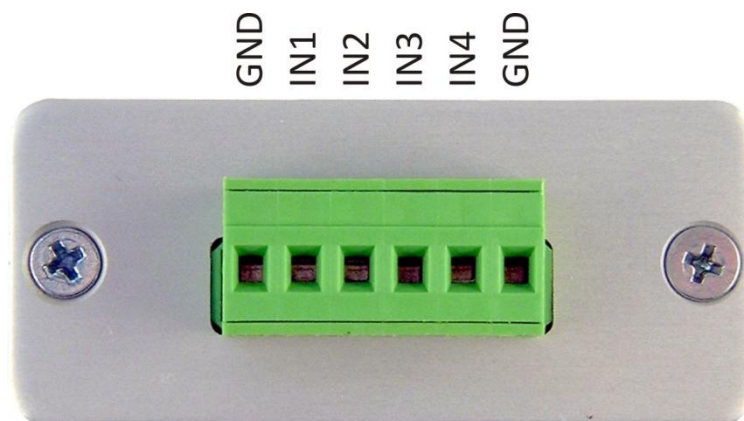

Fig. 5 – measuring terminals

USB

The USB bus provides power supply as well as communication. It shall be connected to the B type connector as illustrated in Figure 6. A – B type USB Cable is recommended for connection to PC.

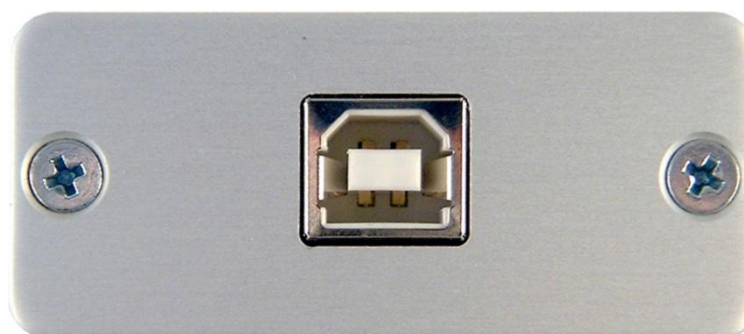

Fig. 6 – USB connector

INSTALLATION

Installation of drivers in OS Windows

(The following pages describe the precise instructions for OS Windows Vista. Procedures applying to the previous systems Windows 2000 and XP are very similar.)

- 1) After connecting the USB cable to AD4USB, the green ON indicator lights up and the systems opens the “Found New Hardware” guide. Here, click on “Locate and install driver software”.

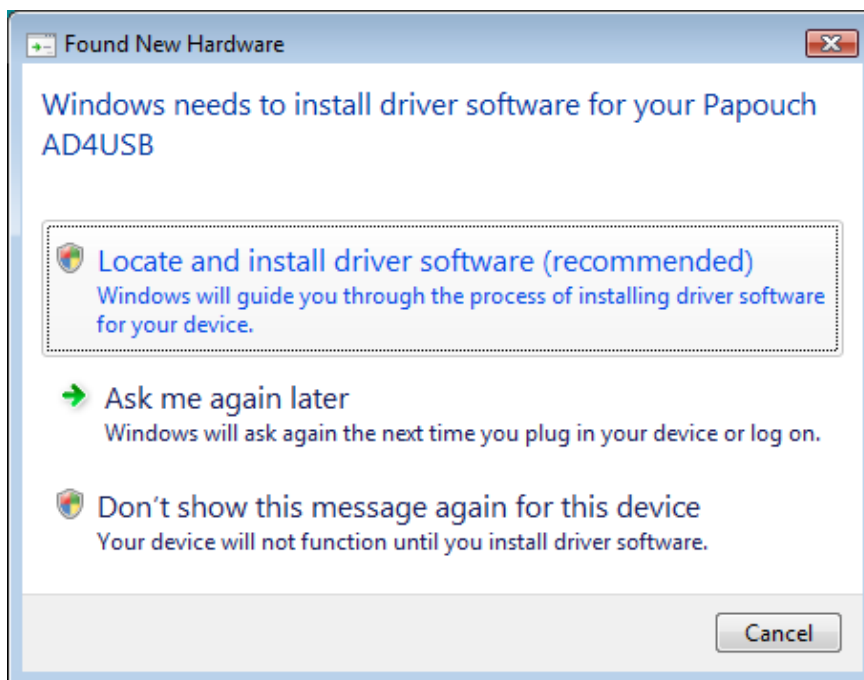

Fig. 7 – New Hardware Found

- 1) Now you will be asked by the “User Account Control” service to confirm the command (“Windows needs your permission to continue”). Click on “Continue” in the window.
- 2) Now the operating system will try to find the driver software automatically.

- 3) If the system fails to find the driver software automatically, the window shown in Figure 10 will be displayed. Here, click “I don’t have the disc. Show me other options”.

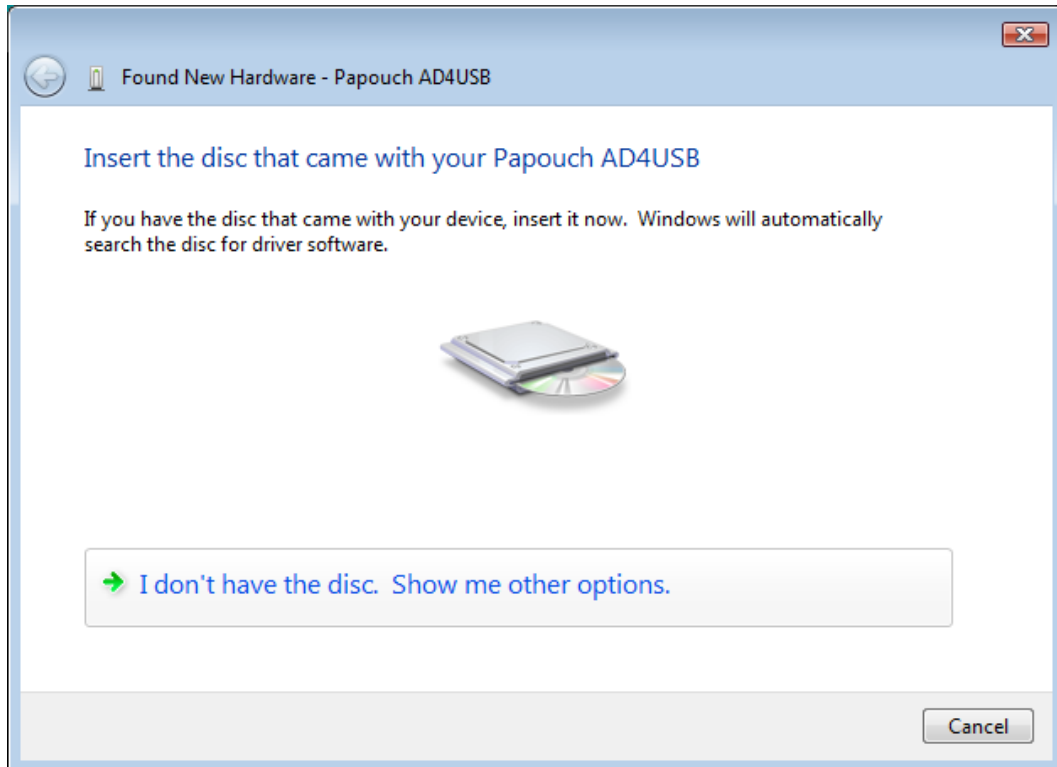

Fig. 8 – Driver software has not been found automatically

- 4) Now choose “Browse my computer for driver software”.

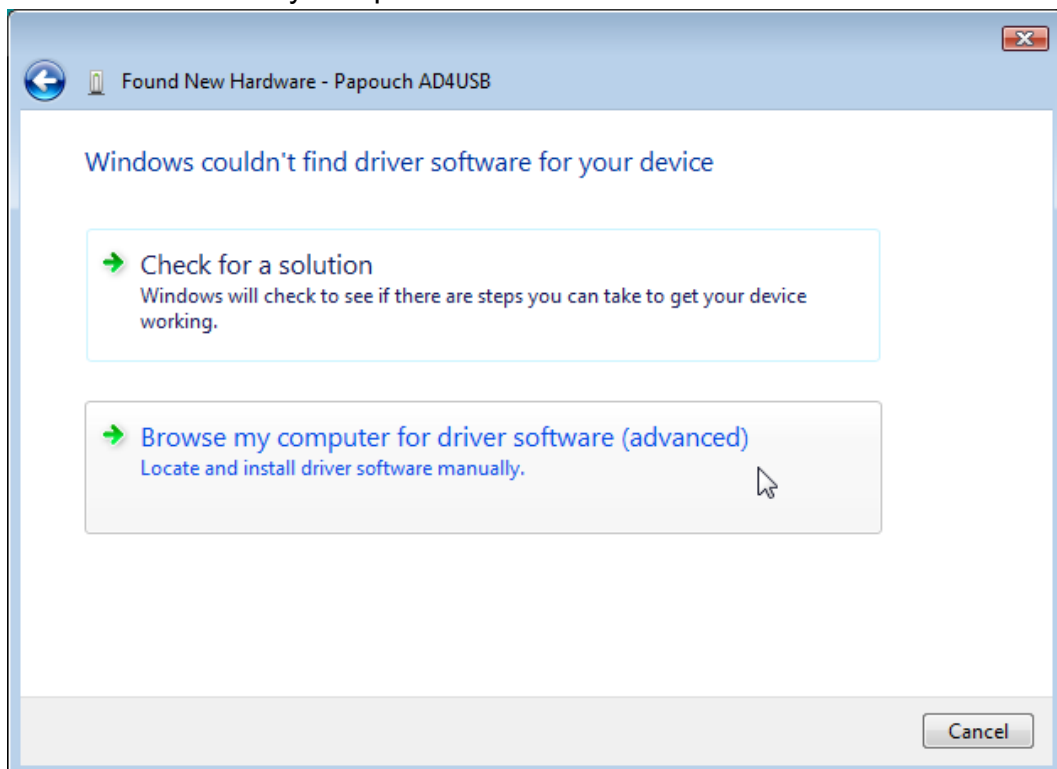

Fig. 9 – Dialog window for locating driver software manually

- 5) Here, find the directory with USB driver software on the provided CD or download the USB driver software from the homepage of the AD4USB device on <http://www.papouch.com/> .

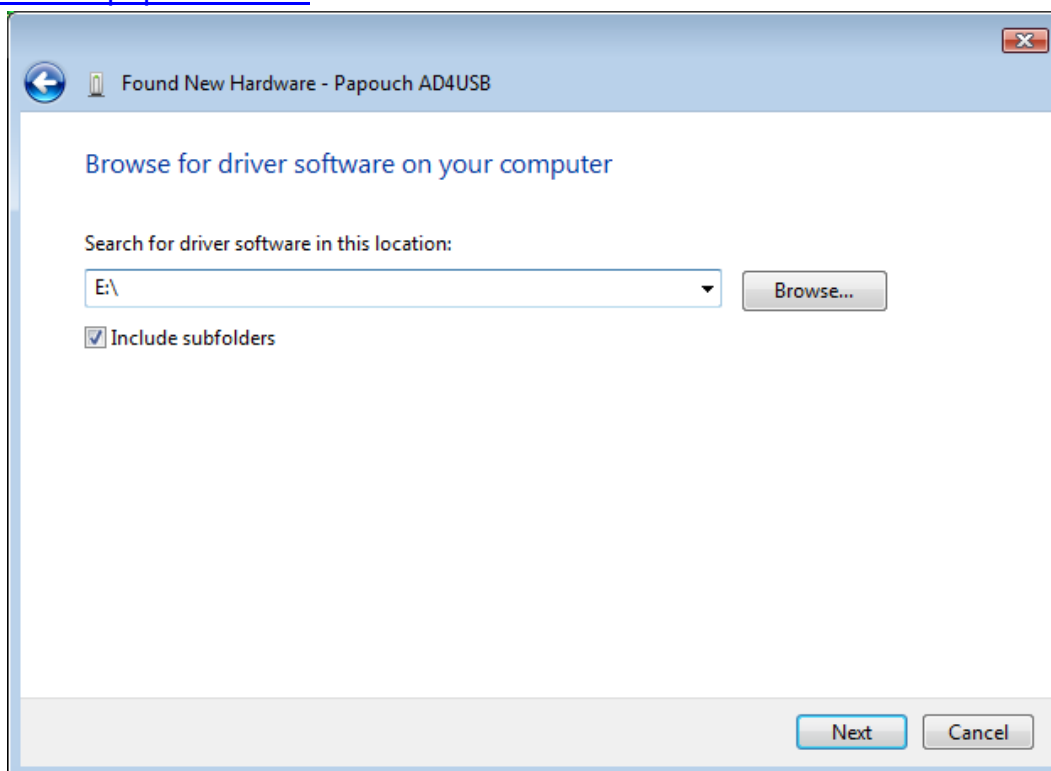

Fig. 10 – Searching for drivers

- 6) Before the installation is started, the system security centre asks the user to confirm that the installation of the driver software is really required. Click “Install this driver software anyway”.

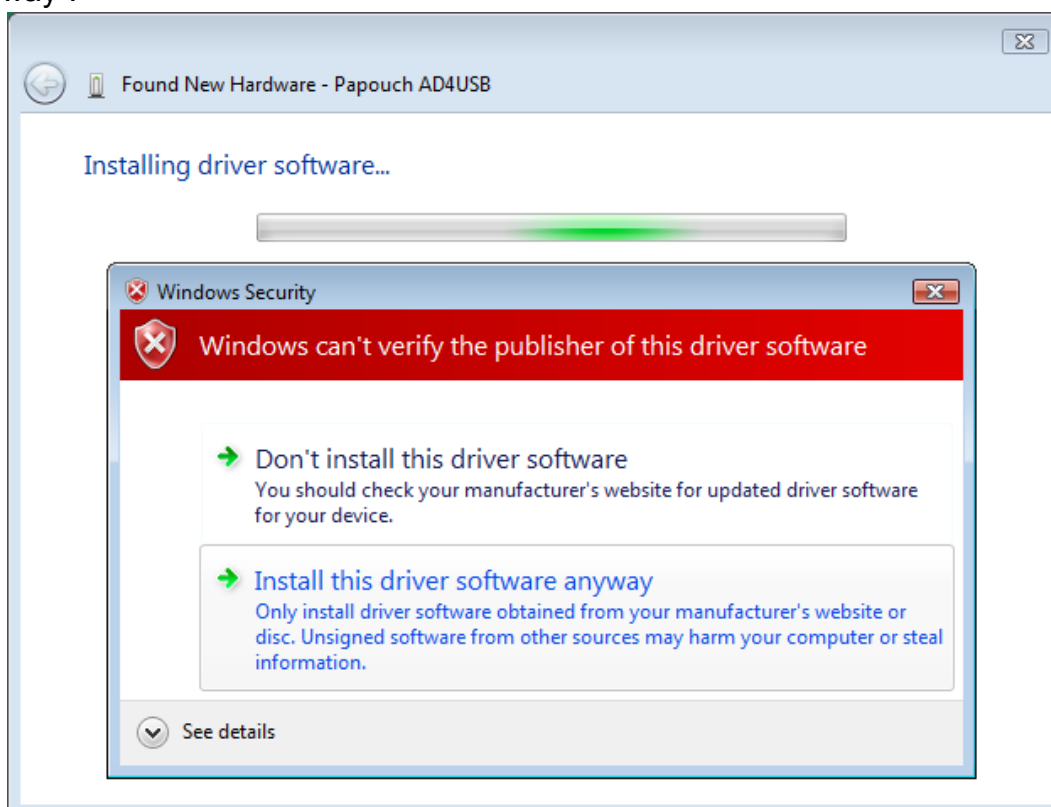

Fig. 11 – Security centre window

- 7) The USB driver software installation has been finished. The system now proceeds to the installation of virtual port...

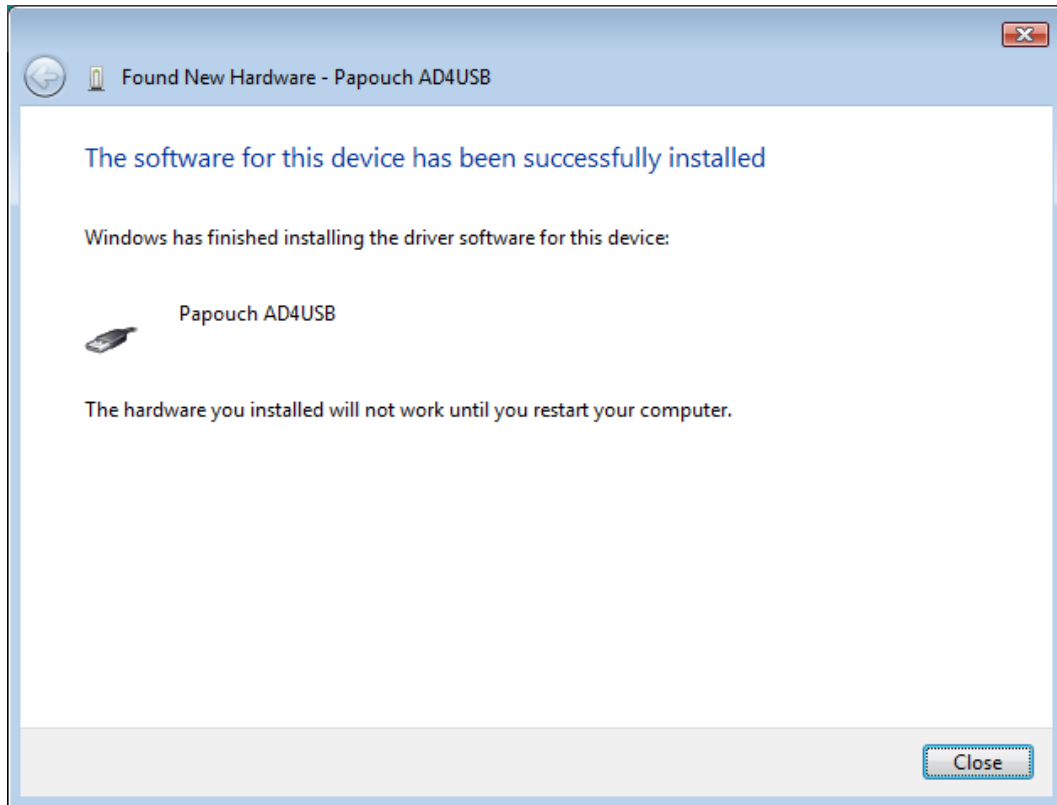

Fig. 12 –USB driver software has been finished

- 8) No drive software for virtual port has been found. Click "I don't have the disc. Show me other options".

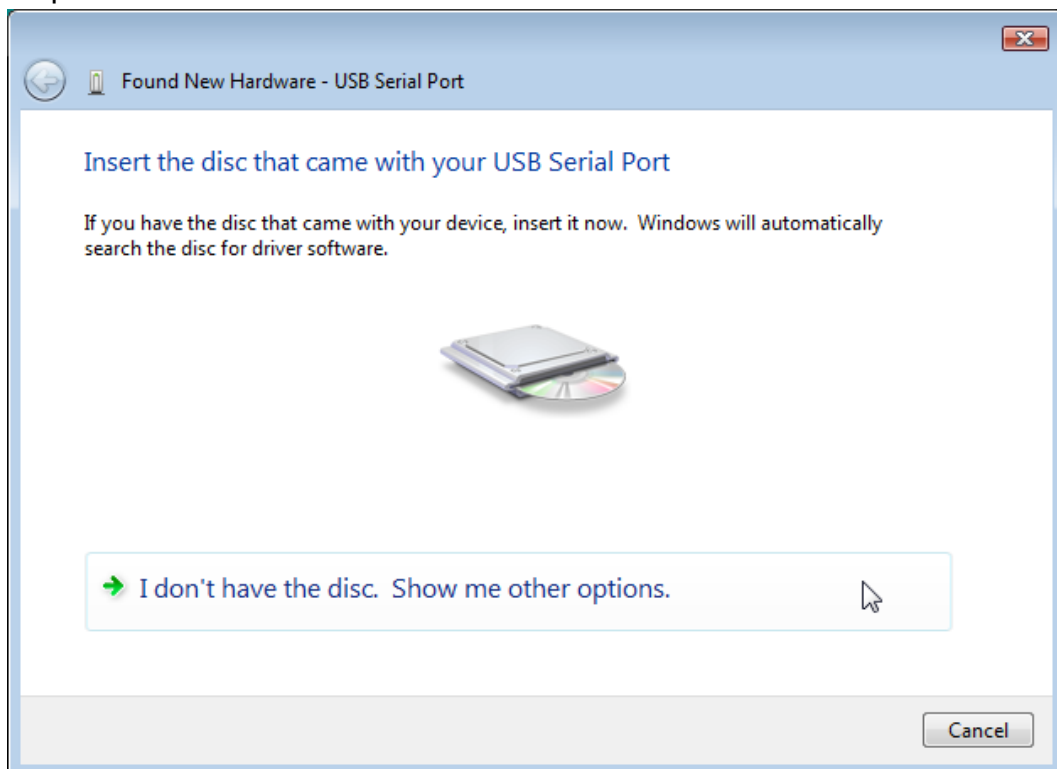

Fig. 13 – Driver software has not been found automatically

9) Now choose “Browse my computer for driver software”.

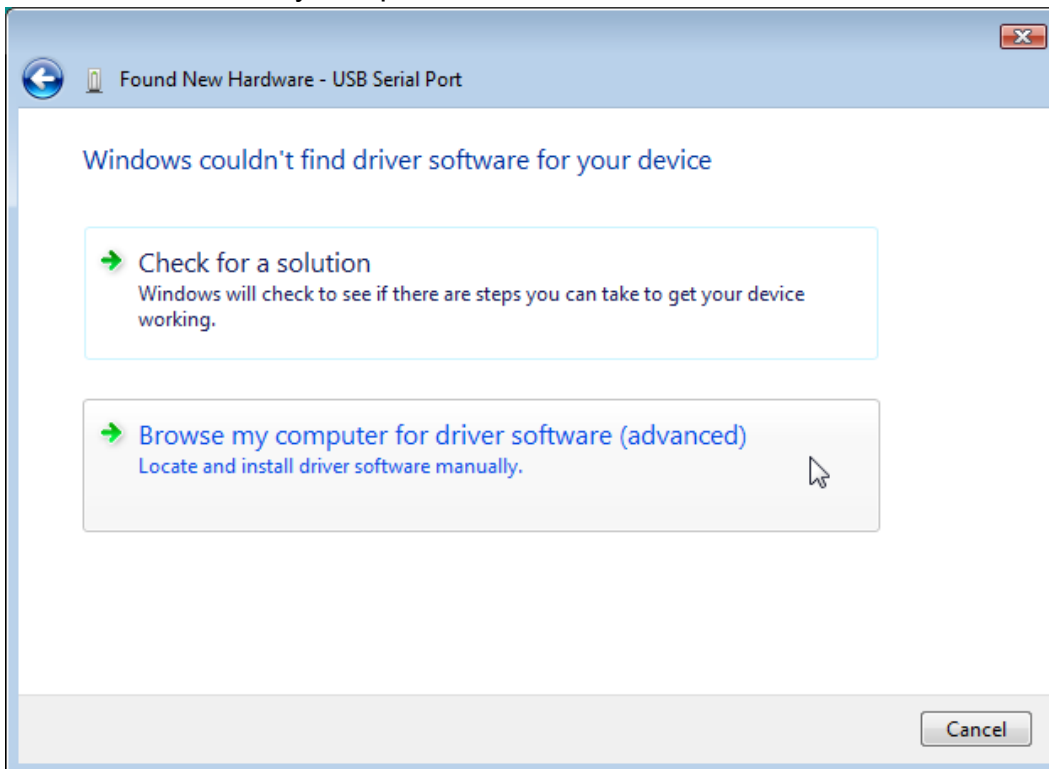

Fig. 14 – Dialog window for locating driver software manually

10) Here, find the directory with driver software on the provided CD or download the driver software from the homepage of the AD4USB device on <http://www.papouch.com/>

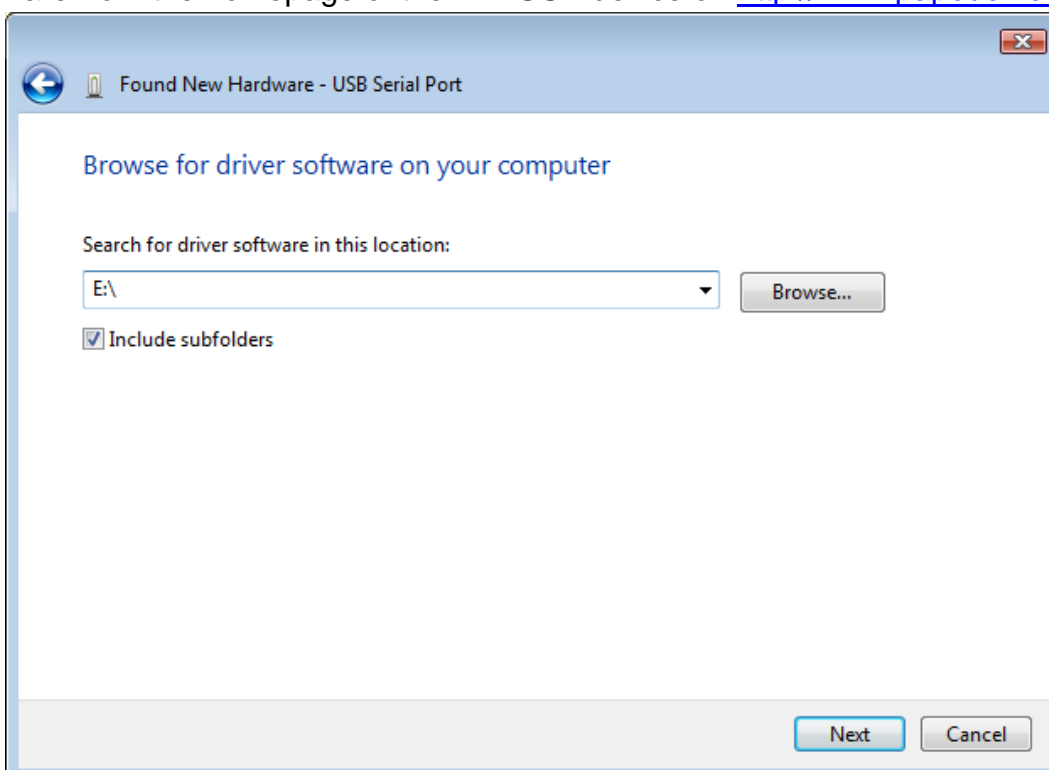

Fig. 15 – Searching for drivers

- 11) Before the installation is started, the system security centre asks the user to confirm that the installation of the driver software is really required. Click “Install this driver software anyway”.

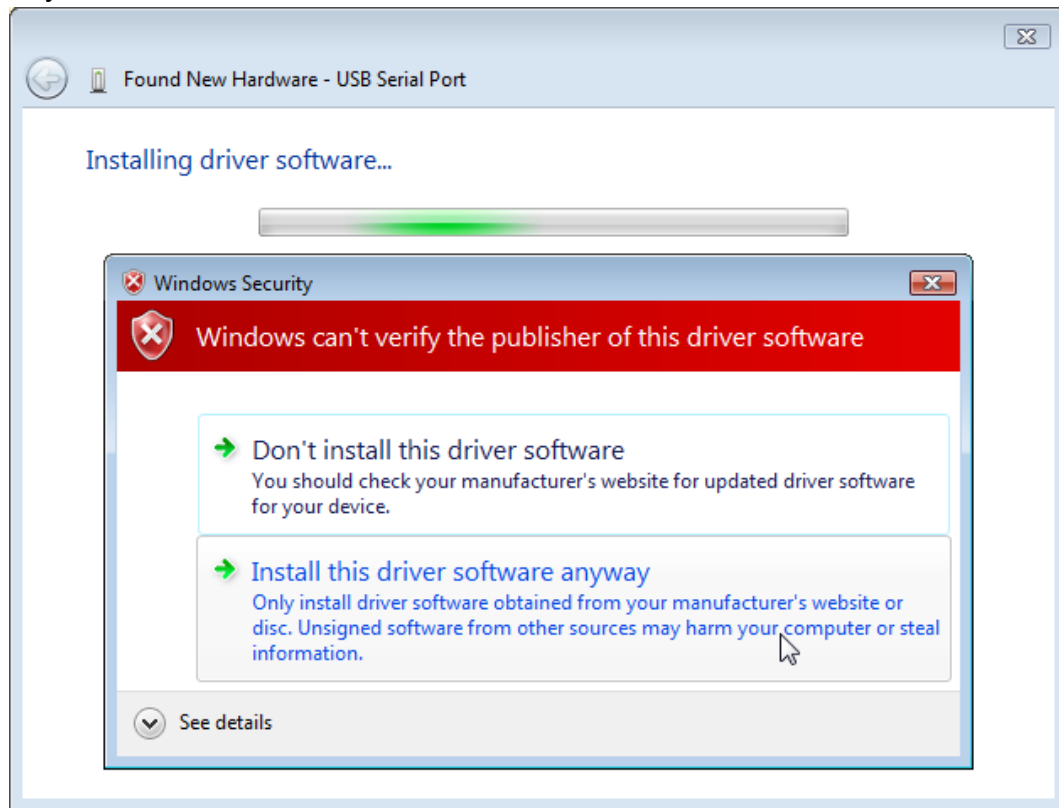

Fig. 16 – Security centre window

- 12) The installation of driver software has been finished.

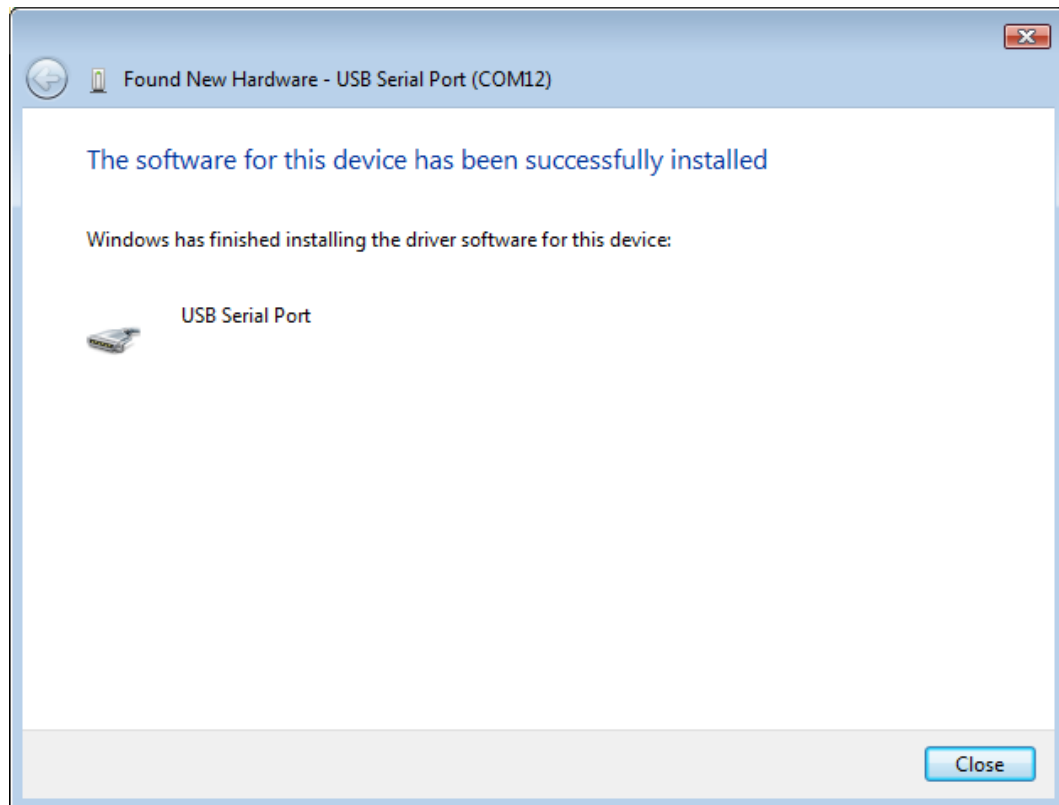

Fig. 17 – Software has been installed successfully

Serial port number change

During the installation the device is allocated the nearest unoccupied port number within the range of 1 to 255. Sometimes it may be necessary to change the port number. Follow the steps below.

- 1) Open the Device Manager. Expand the directory item “Ports (COM a LPT)”, click the right mouse button on “USB Serial Port” and choose “Properties”.

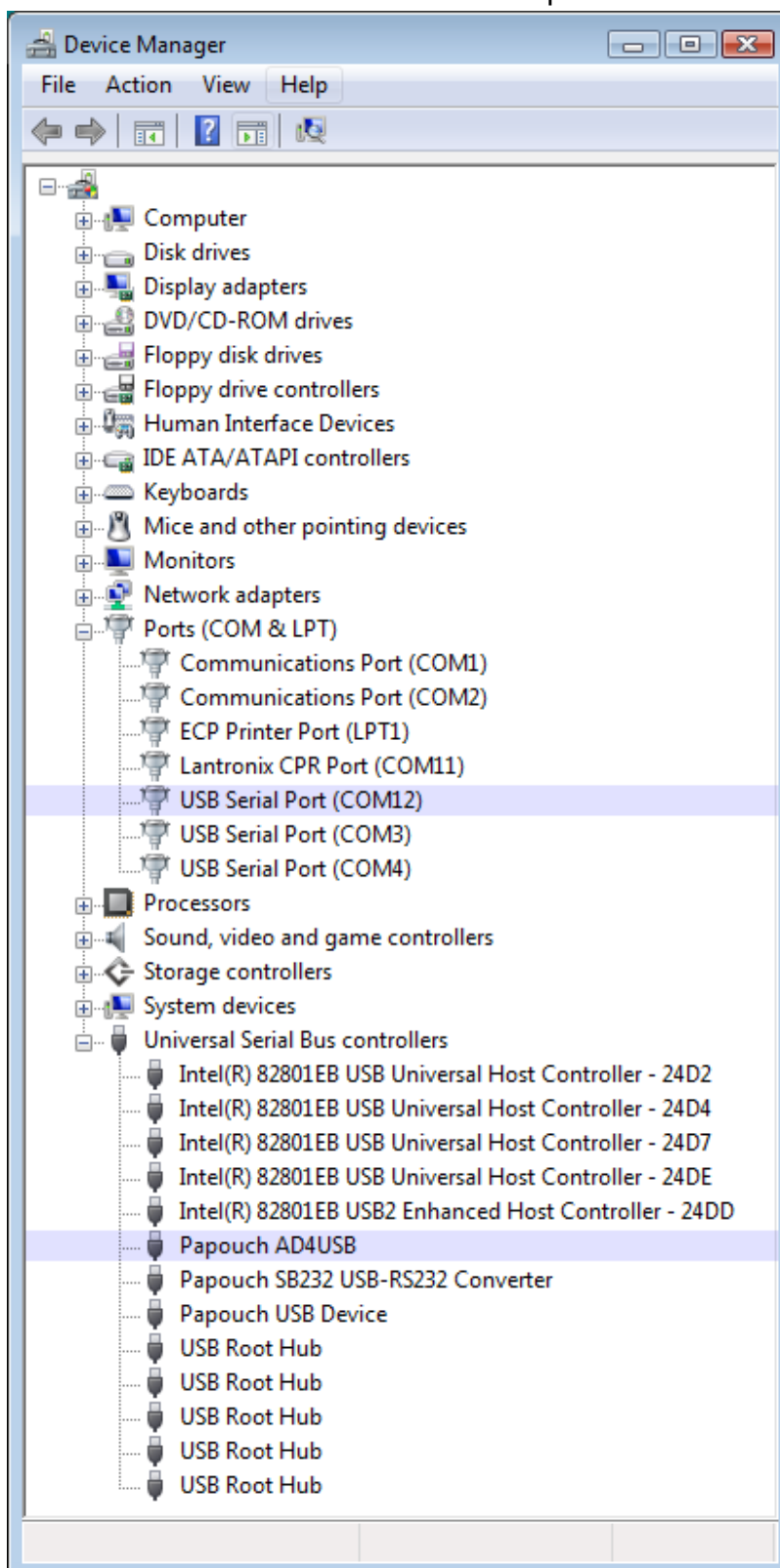

Fig. 18 – Device Manager – items available for AD4USB

- 2) The window shown in Figure 21 will be displayed. Choose the “Port Settings” bookmark and click on “Advanced...”.

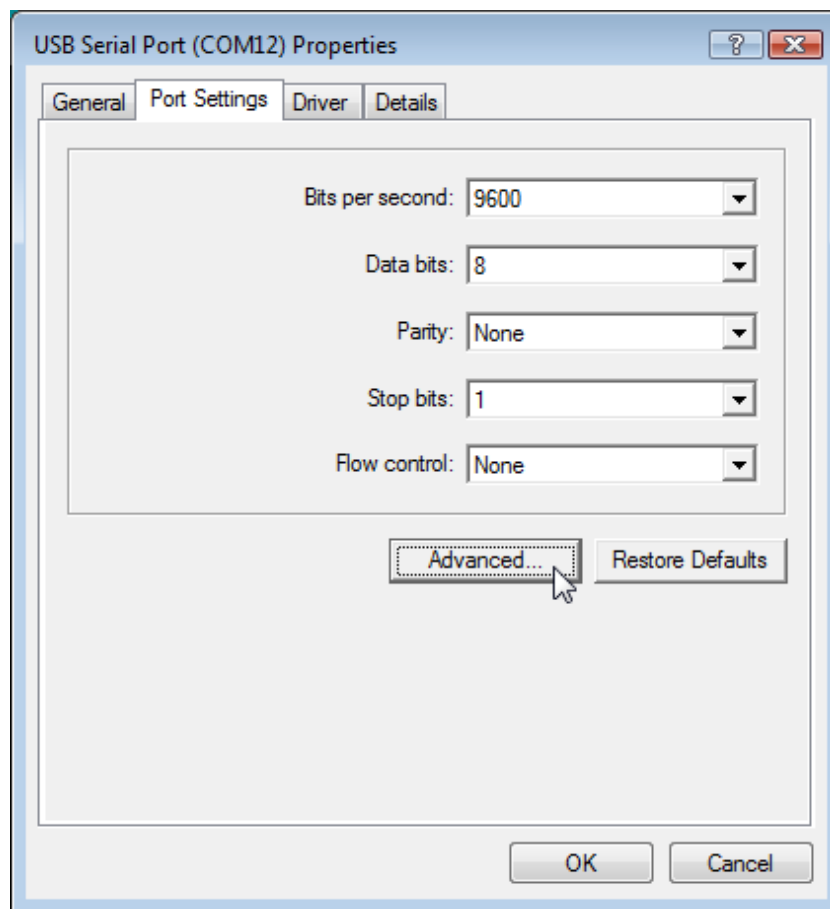

Fig. 19 – Port Settings

- 3) The window shown in Figure 14 contains the “COM Port Number” field. This field shows the current COM port number. The field enables AD4USB port number from 1 to 255 to be selected from a drop-down list. (If you want to allocate a port which is being used by another device, the change will become effective after the original device is allocated with a different port number.)

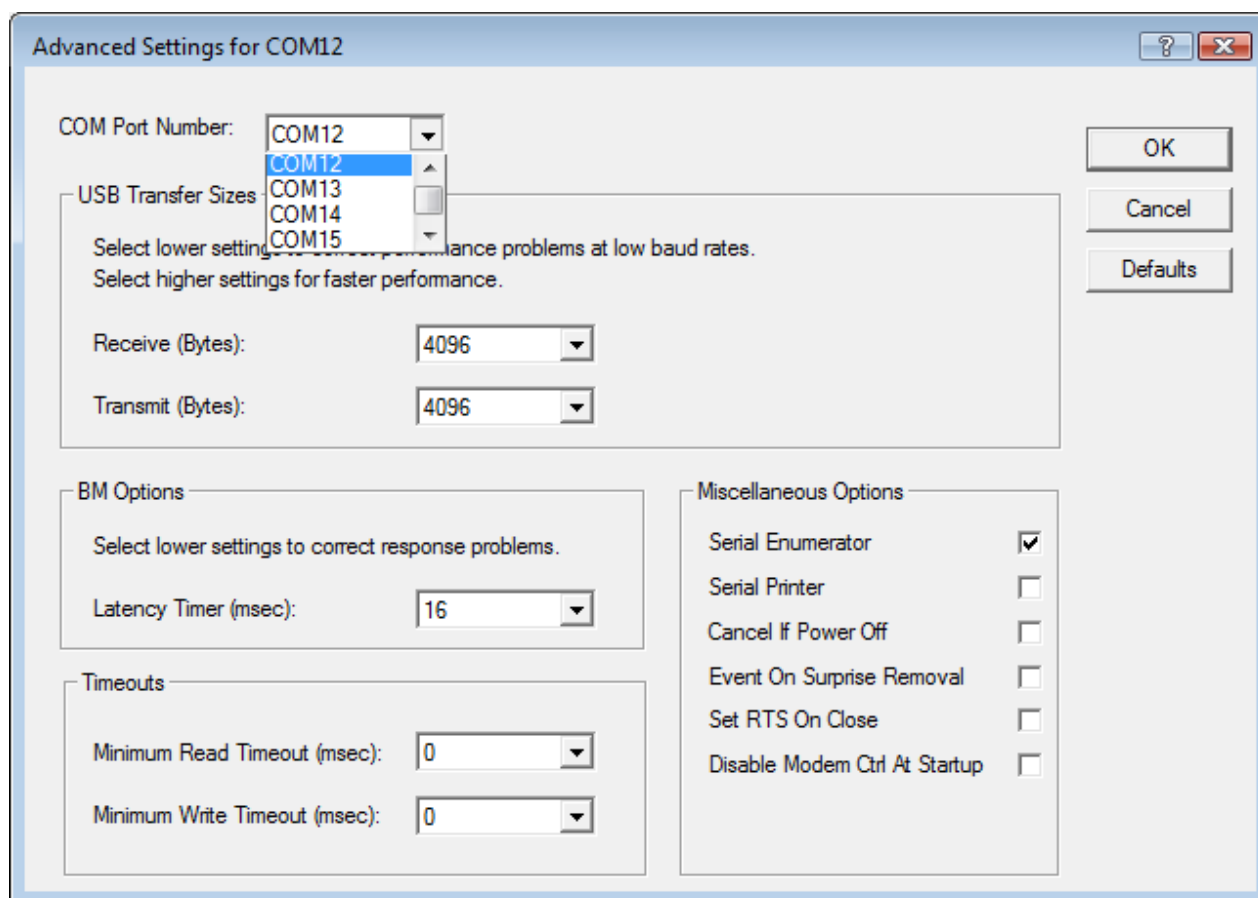

Fig. 20 – Virtual COM port setup

- 4) Click “OK“. Close all windows. In some cases it is necessary to restart the computer for the change to become effective.
- 5) AD4USB now operates with a new port number.

TECHNICAL PARAMETERS

Analog inputs:

Number of inputs	4
Input type.....	unipolar
Voltage input range	0 – 10 V; 10 000 divisions
Input impedance (voltage inputs).....	1 M Ω (100 k Ω / 1 V)
Current input ranges	0 – 20 mA; 4 – 20mA; 10 000 divisions
Calibration	10 000 divisions/range
A/D converter resolution	16 bits
Maximum non-linearity.....	10 divisions
Maximum zero error	10 divisions
Maximum rang error	10 divisions
Maximum measuring speed.....	406 ms (all channels)
Calibration method	software ¹

Control interface:

Type.....	USB version 1.1 (USB 2.0 compatible)
Connector	type B
Communication protocol	Spinel
Communication speed	115 200 Bd (fixed)
Data bits	8
Parity	none
Stop bits.....	1
Isolation	\pm 300 V

Power supply:

Supply voltage	5 V from USB
Power consumption	usually 60 mA

Other parameters:

Operation temperature.....	-20 °C to +70 °C
Dimensions.....	104 mm \times 55 mm \times 24 mm
Dimensions incl. connectors	121 mm \times 55 mm \times 24 mm
Dimensions incl. DIN rail holder.....	104 mm \times 55 mm \times 33 mm
Weight	145 g

¹ Calibration is described in greater detail in the communication protocol description which is available to be downloaded from the device web page.

Available Designs

Assembly:

- Without a holder (*standard design*)
- With a DIN rail holder



Fig. 21 - AD4USB with DIN rail holder

- With a wall holder



Fig. 22 – AD4 with wall holder

Input ranges:

- 0 to 10 V (AD4USB \mathbf{U})
- 0 to 20 mA (AD4USB \mathbf{I})
- 4 to 20 mA (AD4USB \mathbf{I})
- It is possible to deliver another current or voltage range upon request; it is also possible to combine more ranges in one device (AD4USB \mathbf{C})

Do not hesitate to contact us in case of any other special requirements concerning the AD4USB module design and functions.

INDICATIONS

The device contains three light indicators showing the operational status:

ON

Green light. Lights when the USB is connected.

COM

Yellow light indicator. It flashes after the device start-up when the power supply is switched on and when communication is running on the USB.

OVR

Red light. Flashes repeatedly when the input range of any channel has been exceeded.

DETAILED DESCRIPTION OF COMMUNICATION PROTOCOL

The detailed description of Spinel communication protocol used by AD4USB is available for downloading from the AD4USB web page.

Papouch s.r.o.

Data transmission in industry, line and protocol conversions, RS232/485/422/USB/Ethernet/GPRS/WiFi, measurement modules, intelligent temperature sensors, I/O modules, and custom-made electronic applications.

Address:

**Strasnicka 3164
102 00 Prague 10
Czech Republic**

Tel:

**+420 267 314 267
+420 267 314 268
+420 602 379 954**

Fax:

+420 267 314 269

Internet:

www.papouch.com

E-mail:

info@papouch.com

